

KSEM260SEFM

Produktnummer: 3586205

KSEM260SEFM

KSEM FASRING SEFAS D=26.0MM



Spesifikasjoner Kennametal

Vekt	0.74 kg
Bredde/tykkelse	0 mm
Høyde	0 mm
Volum	0 liter
Dimensjon	0
Nøkkelvidde	0 mm
Form	45 GRADER
kW	0
Innvendig diameter	0 mm
Utvendig diameter	0 mm
Type 4	0
Delelengde	0 mm
Type 3	0
Bredde ytre ring	0 mm
Bredde indre ring	0 mm
Type 2	0
Type 5	0
Bordiameter	0 mm
Diameter	26 mm

Neseradius	0 mm
Lengde	0 mm
D5	55.0000
Pakke Størrelse	1
[D] Shank Diameter	26.0000
Beskrivelse	KSEM CHAMFERING RING SEFAS D=26.0MM
[L] Total Lengde	54.0000
Skaft Type	KSEM Chamfer Ring Connection
Plattform	KSEM
[D1] Diameter	26.0000
Varekode	KSEM260SEFM
Maks omd.	Counterbore/Countersink Misc

Se dokumentarkiv
for skjæredata og teknisk
informasjon

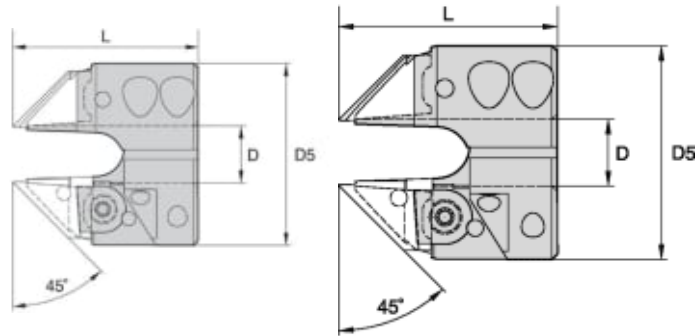

Les mer om produktet her:
<https://www.ail.no/product?number=3586205>