

# KSEM245SEFM

Produktnummer: 3586202

KSEM245SEFM

KSEM FASRING SEFAS D=24.5MM



## Spesifikasjoner Kennametal

Vekt	0.764 kg
Bredde/tykkelse	0 mm
Høyde	0 mm
Volum	0 liter
TypeW	N/A
Dimensjon	0
Nøkkelvidde	0 mm
Form	45 GRADER
Drivtype	N/A
Batterispenning	N/A
Kategori/IP/digital	N/A
kW	0
Modul/profil	N/A
Tanning	N/A
Innvendig diameter	0 mm
Utvendig diameter	0 mm
Type	N/A
Type 4	0
Lengde X dia	N/A

<b>Delelengde</b>	0 mm
<b>Type 3</b>	0
<b>Serie</b>	N/A
<b>Metrisk/tomme</b>	N/A
<b>Kvalitet</b>	N/A
<b>Tekst</b>	N/A
<b>Materiale</b>	N/A
<b>Bredde ytre ring</b>	0 mm
<b>Bredde indre ring</b>	0 mm
<b>Korning</b>	N/A
<b>Type 2</b>	0
<b>Type 5</b>	0
<b>Type 7</b>	N/A
<b>Bordiameter</b>	0 mm
<b>Bortype</b>	N/A
<b>Borelengde</b>	N/A
<b>Diameter</b>	24.5 mm
<b>Neseradius</b>	0 mm
<b>Størrelse</b>	N/A
<b>Lengde</b>	0 mm
<b>Antall tenner/rader/deling/spor</b>	N/A
<b>Bruksområde</b>	N/A
<b>Tange/hull</b>	N/A
<b>D5</b>	55.0000
<b>Pakke Størrelse</b>	1
<b>[D] Shank Diameter</b>	24.5000
<b>Beskrivelse</b>	KSEM CHAMFERING RING SEFAS D=24.5MM
<b>[L] Total Lengde</b>	54.0000
<b>Skaff Type</b>	KSEM Chamfer Ring Connection
<b>Plattform</b>	KSEM
<b>[D1] Diameter</b>	24.5000
<b>Varekode</b>	KSEM245SEFM
<b>Maks omd.</b>	Counterbore/Countersink Misc

Se dokumentarkiv  
for skjæredata og teknisk  
informasjon

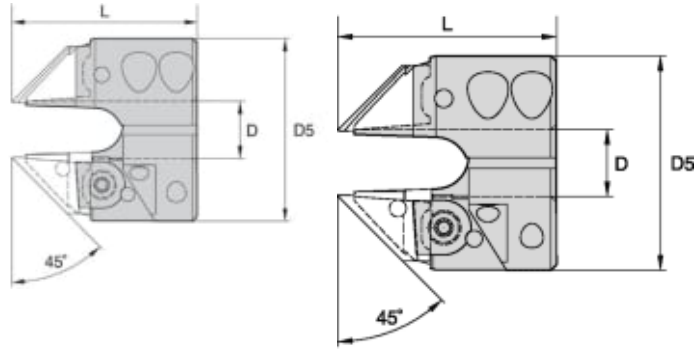

Les mer om produktet her:

<https://www.ail.no/product?number=3586202>