

KSEM140SEFM

Produktnummer: 3586091

KSEM140SEFM

KSEM FASRING SEFAS D=14.0MM



Spesifikasjoner Kennametal

Vekt	0.158 kg
Bredde/tykkelse	0 mm
Høyde	0 mm
Volum	0 liter
Dimensjon	0
Nøkkelvidde	0 mm
Form	45 GRADER
kW	0
Innvendig diameter	0 mm
Utvendig diameter	0 mm
Type 4	0
Delelengde	0 mm
Type 3	0
Bredde ytre ring	0 mm
Bredde indre ring	0 mm
Type 2	0
Type 5	0
Bordiameter	0 mm
Diameter	14 mm

Neseradius	0 mm
Lengde	0 mm
D5	40.0000
Pakke Størrelse	1
Beskrivelse	KSEM CHAMFERING RING SEFAS D=14.0MM
[D] Shank Diameter	14.0000
LS	46.000
[L] Total Lengde	40.0000
Skaft Type	KSEM Chamfer Ring Connection
Platform	KSEM
[D1] Diameter	14.0000
Varekode	KSEM140SEFM
L2	46.0000
Maks omd.	Counterbore/Countersink Misc

Se dokumentarkiv
for skjæredata og teknisk
informasjon

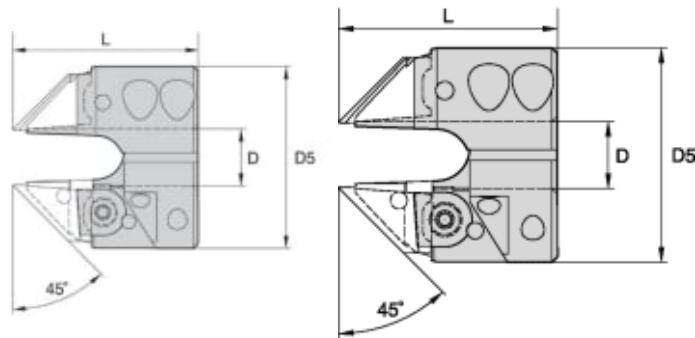

Les mer om produktet her:

<https://www.ail.no/product?number=3586091>