

KSEM2950FEGM KCPM45 FLAT BOTTOM

Produktnummer: 5981598

KSEM2950FEGMKCPM45

KSEM SCHNEIDKOERPER FEG 29.50 MM



Spesifikasjoner Kennametal

Vekt	0.042 kg
Bredde/tykkelse	0 mm
Høyde	0 mm
Volum	0.02 liter
Dimensjon	0
Nøkkelvidde	0 mm
Form	FEG
kW	0
Innvendig diameter	0 mm
Utvendig diameter	0 mm
Type	0
Type 4	0
Delelengde	0 mm
Type 3	0
Bredde ytre ring	0 mm
Bredde indre ring	0 mm
Type 2	0
Type 5	0
Bordiameter	29.5 mm

Bortype	0
Diameter	0 mm
Neseradius	0 mm
Lengde	0 mm
Kvalitet	KCPM45
Pakke Størrelse	1
Beskrivelse	KSEM INSERT FEG 29.50 MM
Platform	KSEM
Material Hoved Grupper	Steel,Stainless Steel,Cast Iron,High-Temp Alloys,Non-Ferrous Materials
Varekode	KSEM2950FEGM
Maks omd.	KSEM Drill

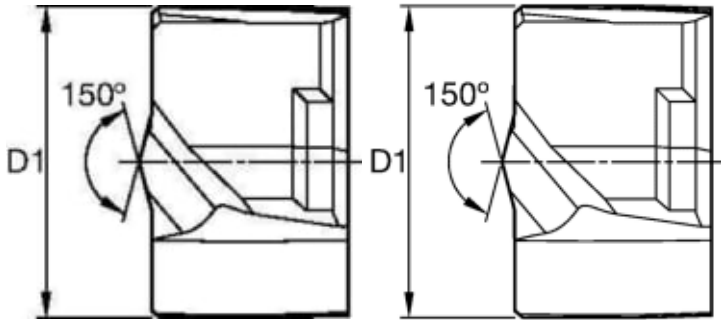

Les mer om produktet her:

<https://www.ail.no/product?number=5981598>